

RS232/RS485 TO RJ45&WIFI CONVERT SERVER

(USR-WIFI232-610/604/602/2)

File version: Ver2.0.3



Content

1. Quick Start.....	4
1.1. Hardware connect.....	4
1.2. Network connection.....	4
1.3. Communication test.....	6
2. Introduction.....	7
2.1. Short Description.....	7
2.2. Device Features.....	7
2.3. Electronic Parameters.....	7
2.4. Packing Information.....	9
3. Hardware.....	9
3.1. Appearance size chart.....	9
3.2. Indicator Light.....	9
3.3. Interface Instructions.....	10
4. Application.....	11
4.1. Application of AP.....	11
4.2. Application of STA.....	12
4.3. Application of AP+STA.....	12
4.4. Wired and wireless Application drawing (Only 610 apply).....	13
4.5. Application of wireless serial port(one AP, one STA).....	14
5. Function Description.....	15
5.1. User configuration process.....	15
5.2. Working mode.....	16
5.2.1. Transparent Transmission Mode.....	16
5.2.2. Serial command mode.....	17
5.2.3. HTTPD Client mode.....	18
5.3. WI-FI parameter setting.....	19
5.3.1. Auto- Frequency Function.....	19
5.3.2. Security.....	19
5.3.3. Search Function for STA.....	19
5.3.4. Address Binding.....	20
5.4. UART Frame Scheme.....	20
5.4.1. UART Free-Frame.....	20
5.4.2. UART Auto-Frame.....	20
5.5. Network Setting.....	21
5.5.1. Socket A.....	21
5.5.2. Socket B.....	21
5.6. New function.....	22
5.6.1. TCP password authentication.....	22
5.6.2. Upload ID.....	22

5.6.3. Self-adaption Baudrate.....	22
5.6.4. Keepalive.....	23
5.6.5. Multiple STA parameters.....	23
5.6.6. Websocket.....	23
5.7. Palmodic Signal.....	24
5.8. Parameters Configuration.....	24
5.9. Firmware Upgrade.....	25
6. setup process.....	25
6.1. Configuration via Web Accessing.....	25
6.1.1. Open Web Management Interface.....	25
6.1.2. Quick Configure.....	26
6.1.3. Mode Selection Page.....	27
6.1.4. AP Interface Setting Page.....	28
6.1.5. STA Interface Setting Page.....	28
6.1.6. Application Setting Page.....	29
6.1.7. Ethernet Setting.....	31
6.1.8. HTTPD Client Mode.....	31
6.1.9. Device Management Page.....	32
Appendix A: Questions and Answers.....	34
Q1: How to configure transparent serial port application (TCP protocol) with two Convert Servers?.....	34
Q2: Where to Set WIFI Convert Server LAN IP and WAN IP through Web Page?	35
Q3: How to configure transparent serial port application (UDP protocol) with two Convert Servers?.....	35
Q4: Where to set Convert Server network protocol (TCP/UDP)?.....	36
Q5: How to configure transparent serial port application: Two Convert Servers all configured as STA and connection through AP?.....	37
Q6: How to avoid IP address confliction when apply Convert Server?.....	38
Q7: PC works as server, all Convert Servers works as data acquisition card and connect with PC, how to configure this application?.....	38
Q8: Convert Server support UDP multicast?.....	40
Q9: Convert Server operates in STA mode, the PC how to get the IP Convert Server?.....	40
Appendix B: Contact.....	41
Appendix C: Disclaimer.....	41
Appendix D: Update History.....	41

1. Quick Start

This chapter is the quick start for Convert Server. proposal user read this chapter and follow the instructions. This will help your understanding of the product. Of course, the user can choose read chapters according to need .For specific details and instructions, please refer to the following.

If there are problems in using the process, you can refer to the official website of our application case:

<http://www.usriot.com/Faq/cat-47.html>

We can also submit the issue to our customer support center:

<http://h.usriot.com>

1.1. Hardware connect

In order to test the serial port to the WIFI/ Ethernet communication transformation,connect the the device serial port to PC serial port, connect the device WIFI/Ethernet to PC WIFI/Ethernet.If the desktop does not own the serial port, also can use USB 232 to replace. The hardware environment.

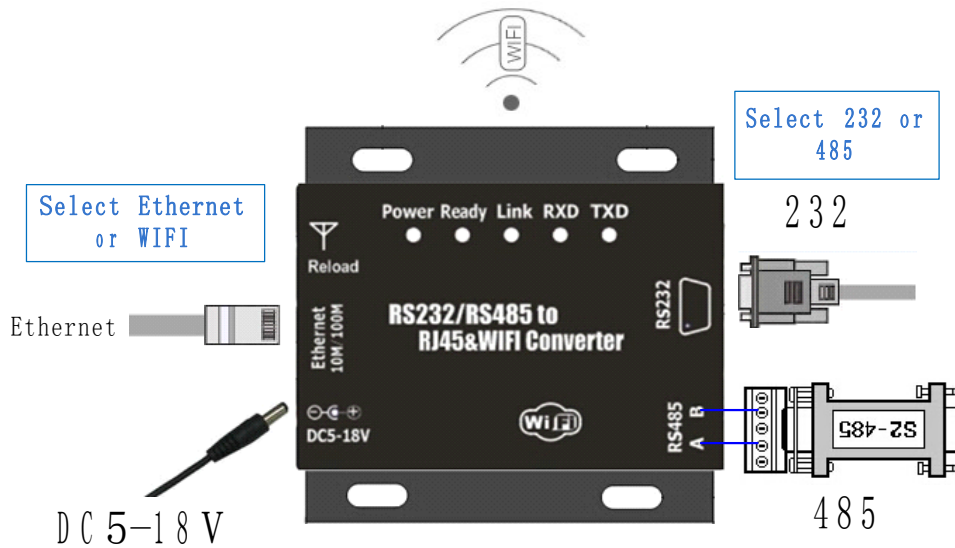

Figure 1 Hardware Connect(610)

According to the above connect Convert Server.

1.2. Network connection

Open Wi-Fi, search network on the PC, as shown in below, USR-WIFI232-XXX_xxxx (XXX is the specific name of Convert server)is the default network name (SSID) of the Convert Server.

Note: if the firmware version is V4, the SSID is "HF-A11x_AP".After the SSID is also like this.

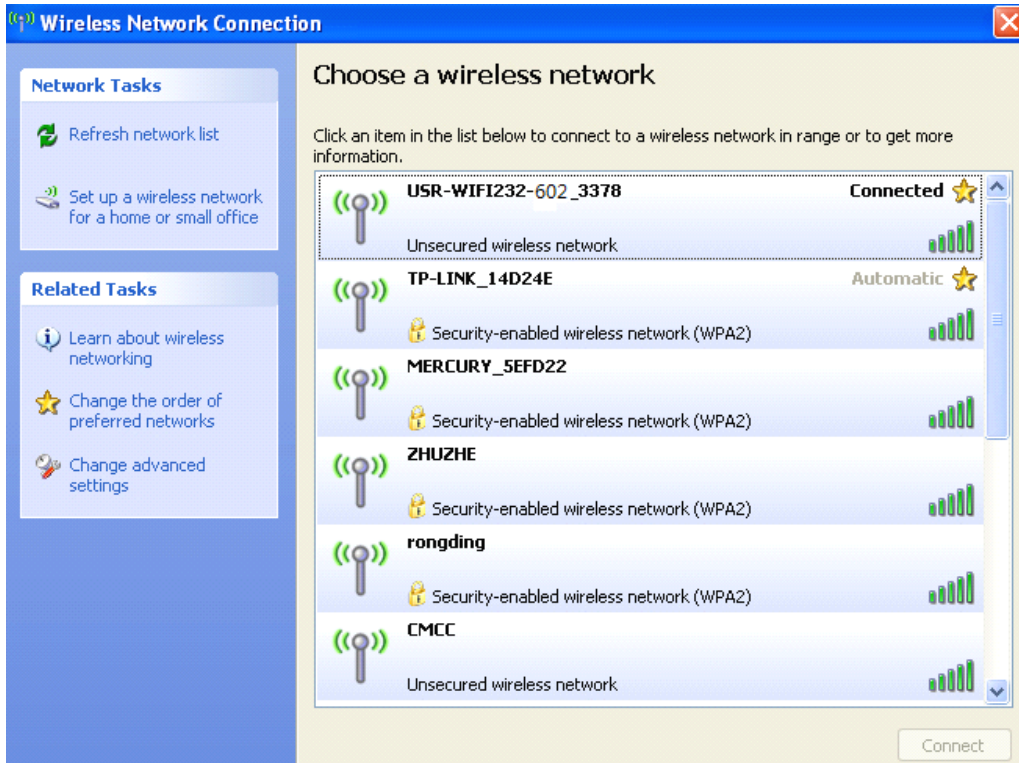

Figure 2 WIFI Search

Join the network, choose to automatically obtain IP, Convert Server supports DHCP Server feature and is enabled by default.

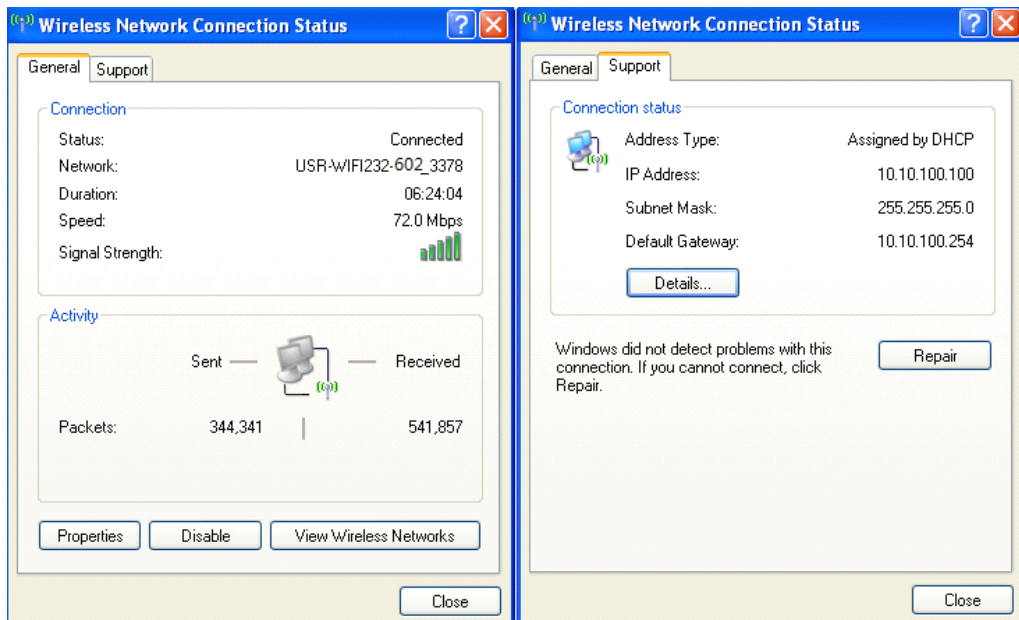

Figure 3 WIFI connection

Now, link led of Convert Server is lighting.

1.3. Communication test

Convert Server' s default setting:

- **SSID:**USR-WIFI232-XXX_xxxx(xxxx is the last of mac address);
- **Encryption mode:**open, none;
- **UART:**57600,8,1,None;
- **Network parameters:** TCP,Server,8899,10.10.100.254;
- **IP:**10.10.100.254;

We just need to follow the parameters of the corresponding set of network communication parameters, you can make serial <--> WIFI or Ethernet communication, the steps are as follows:

1. Open test software USR-TCP232-Test;
2. COM Settings area (left):

Choose COM port witch has connect the Convert Server, there is COM3, choose band rate to 57600, this is the default band rate of Convert Server, Click Open COM port.

3. Net Settings area (right):

Choose TCP client mode, Server IP write 10.10.100.254, it is the WIFI default IP address, Server port to 8899, It is the default Port the Convert Server listen, Click Connect to link to the Convert Server.

Now, you can test send data between RS232 and WIFI.

COM port to WIFI: PC RS232 -> Convert Server RS232 -> Convert Server WIFI -> PC WIFI.

WIFI to COM port: PC WIFI or Ethernet -> Convert Server WIFI or Ethernet -> Convert Server RS232 -> PC RS232.

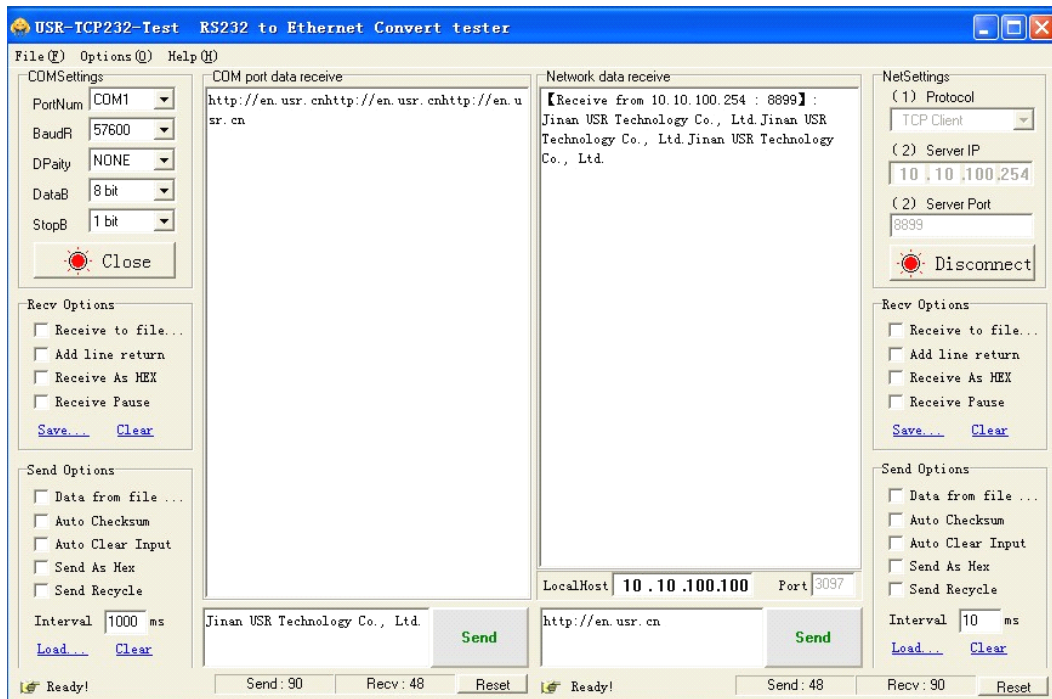

Figure 4 serial / network transmission test

2. Introduction

2.1. Short Description

Convert Server provides a serial port to WIFI function, can be RS-232/485 converted into a TCP/IP serial network interface, RS-232/485 serial port and WIFI/ Ethernet bidirectional data transparent transmission. The serial device can immediately with the TCP/IP network interface functions, connect to the network for data communication, communication range extended serial device greatly.

Convert Server series currently has USR-WIFI232-610, USR-WIFI232-604, USR-WIFI232-602, USR-WIFI232-2 lighting products. Specific parameters of each product please refer to below:

Table 1 Product model

Type	RS232	RS485	Ethernet	Input Voltage	Size(mm)
USR-WIFI232-610	YES	YES	YES	5-18V	84*84*25
USR-WIFI232-604	NO	YES	NO	5-9V	84*84*25
USR-WIFI232-602	YES	NO	NO	5-9V	84*84*25
USR-WIFI232-2	YES	NO	NO	5-9V	80*50*14 (No Shell)

2.2. Device Features

- Inner board core module specifications, please reference to USR-WIFI232-B/C
- Support hardware flow control (RTS/CTS) RS232 interface, male mouth(needle) consistent with computer pin definition
- RS232 RS485 automatic switching(USR-WIFI232-610)
- RJ45 network connection, support wired Ethernet transmission(USR-WIFI232-610)
- Reload button, do not worry incorrect settings(in working status, press the button 3s then it load to default settings and automatic restart)
- Rich status indicator light: Power/Ready/Link/RXD/TXD
- Pin 9 of the DB9 can be connected to power input (solder jumper on the back of PCB), used for power the sensor or the serial port cable power Convert Server.
- Design with positioning hole, convenient installation
- Highest support baud rate 460800 bps
- optional TCP Server/TCP Client/UDP Client/ UDP Server mode, the TCP Server mode can support up to 32 Client connection

2.3. Electronic Parameters

Table 2 Electrical parameter

	Item	Parameter
Wireless parameter	Certification	FCC/CE
	Wireless standard	802.11 b/g/n
	Frequency range	2.412GHz-2.484GHz
	Transmit power	802.11b: +20dBm(Max.)
		802.11g: +18dBm(Max.)
		802.11n: +15dBm(Max.)
		configurable
	Receiver Sensitivity	802.11b: -89dBm
802.11g: -81dBm		
802.11n: -71dBm		
Antenna Option	External 3Dbi antenna	
Hardware Parameters	Data Interface	UART: 1200bps - 230400bps
		Ethernet: 100Mbps
		GPIOs
	Operating voltage	5-18V (+/-5%)
	Operating current	170mA~300mA
	Operating temperature	-40°C- 85°C
	Storage temperature	-40°C- 125°C
Dimensions	83×80×25mm	
Software parameters	Network type	Station/AP mode, STA+AP
	Security mechanisms	WEP/WPA-PSK/WPA2-PSK
	Encryption	WEP64/WEP128/TKIP/AES
	Work mode	Transparent Transmission
	Serial command	AT+instruction set
	Network Protocol	TCP/UDP/ARP/ICMP/DHCP/DNS/HTTP
	Max. TCP Connection	32
	User Configuration	Web Server+AT command config
	User Application SW	Support customized application software

2.4. Packing Information

- ◆ Convert Server *1
- ◆ 5V1A power adapter *1
- ◆ Serial cable *1(only USR-WIFI232-610)
- ◆ Network cable *1(only USR-WIFI232-610)

3. Hardware

3.1. Appearance size chart

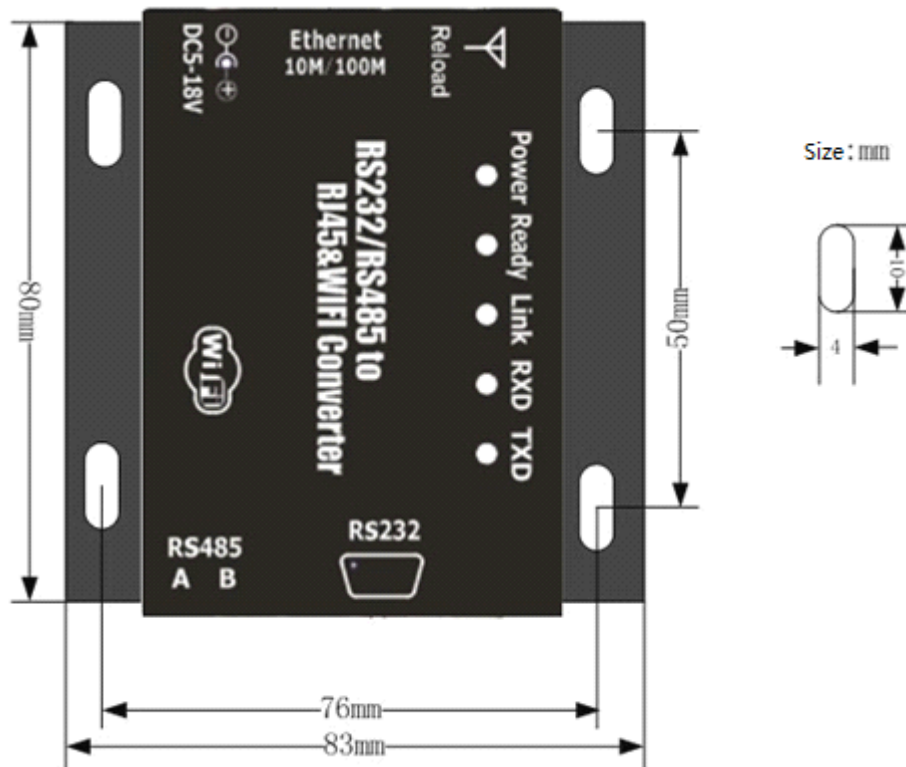

Figure 5 Appearance size chart(602/604/610)

3.2. Indicator Light

There are 5 lights in total, from left to right

Table 3 Indicator light

Indicator	Function	Description
Power	power	Keep light when power on

Ready	Inner LINUX start	Keep green light when connected to network correctly
Link	Network link	Light when establish network link
TXD	Transmit data	Flash when send data
RXD	Receive data	Flash when receive data

3.3. Interface Instructions

Power interface:

5.5*2.1 standard 5-18v power interface, with TVS protection

RS232 interface:(USR-WIFI232-610/602/2)

Device serial port is male(needle), RS232 level (can connect to PC directly), pin order is consistent with PC COM port. Use cross cable connected with PC(2-3cross,7-8cross, 5-5 direct, 7-8 can disconnect, but MUST NOT connect with PC directly), There are 6 pins in work, others is NC.

Table 4 RS232 Pins

ID	NAME	DESCRIPTION
2	RXD	Receive data pin
3	TXD	Send data pin
5	GND	Data Ground
7	RTS	Request to send
8	CTS	Clear to send
9	VCC	Can connect to Convert Server power input by join the PCB jumper, default not connect.

RS485 interface:(USR-WIFI232-610/604)

RS485 two wire links, A(DATA+), B(DATA-), when link to other RS485 device, A(+) to A(+), B(-) to B(-).

RJ45 interface:(USR-WIFI232-610)

Network port connection, Convert Server is 10M/100M adaptive, support AUTO MDI/MDIX, which means you can use direct network cable to connect with PC also can be tested. Convert Server by default open, as shown in the Convert Server specifications.

Table 5 RJ45 Pins

ID	TAB	FUNCTION
1	TX+	Transceiver Data+
2	TX-	Transceiver Data-

3	RX+	Receive Data+
4	PHY-VCC	Transformer tap voltage
5	PHY-VCC	Transformer tap voltage
6	RX-	Receive Data-
7	n/c	Not connected
8	n/c	Not connected

Reload key:

This key used for set up the Convert Server to factory setting, when Convert Server is working (Ready LED on), press this key more than 1 seconds and free it, wait about 10 seconds until the Convert Server restart, the green LEDs all off and then Ready LED on. Then the Convert Server goes to factory default settings.

4. Application

4.1. Application of AP

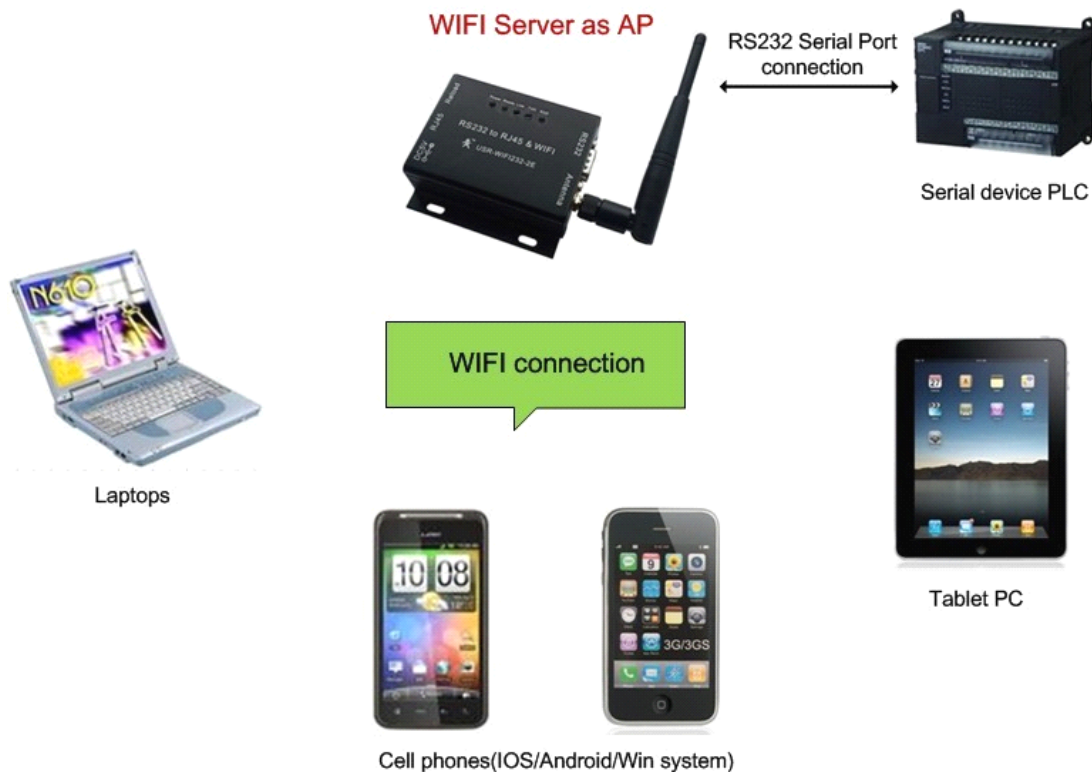

As shown in figure in, Convert Server used as an AP, all the other Convert Servers and computer can be used as the STA to connect this Convert Server, at the same time it also can through the UART or GPIO interface to the user equipment.

4.2. Application of STA



Convert Server as STA (use the AP CLI interface), connect to other AP, to compose a wireless network. All of the STA take AP as the wireless network center, and the mutual communication between STA is through AP forwarding.

4.3. Application of AP+STA

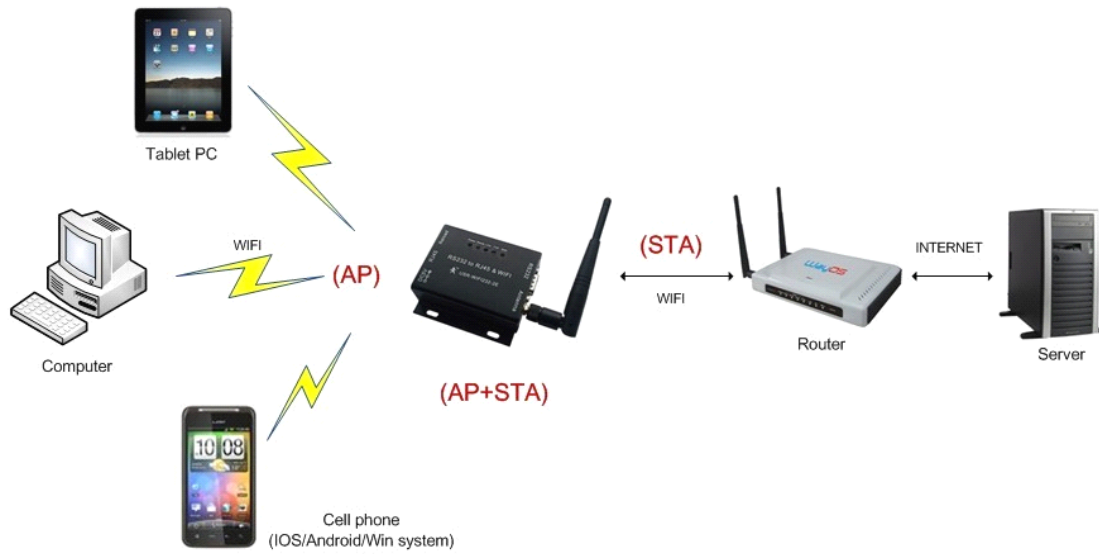

Convert Server can support AP+STA mode. That is the Convert Server support a AP interface and a STA interface at the same time.

AP+STA function settings:

AP+STA function need to set through serial command.

AT+FAPSTA=on set AP+STA function

Then set Convert Server to STA mode, the AP interface still valid.

Note: the AT command part of this article is no longer in detail, please click the high-performance series Convert Server specification.

4.4. Wired and wireless Application drawing (Only 610 apply)

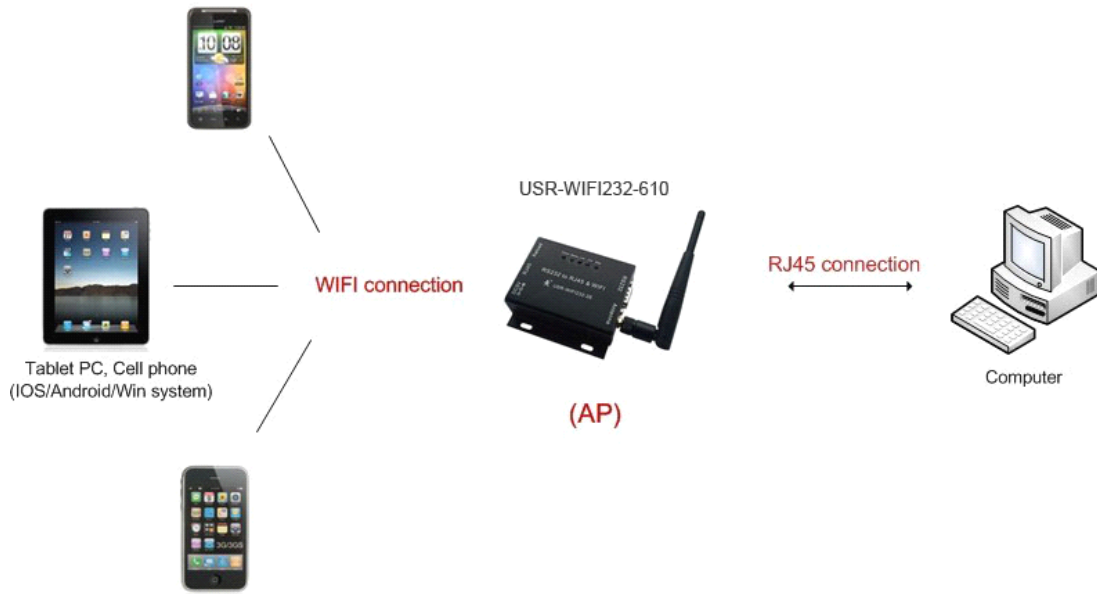

When USR-WIFI232-610 used as AP, other computers and equipments can be used as STA connected to this device through RJ45(network cable).

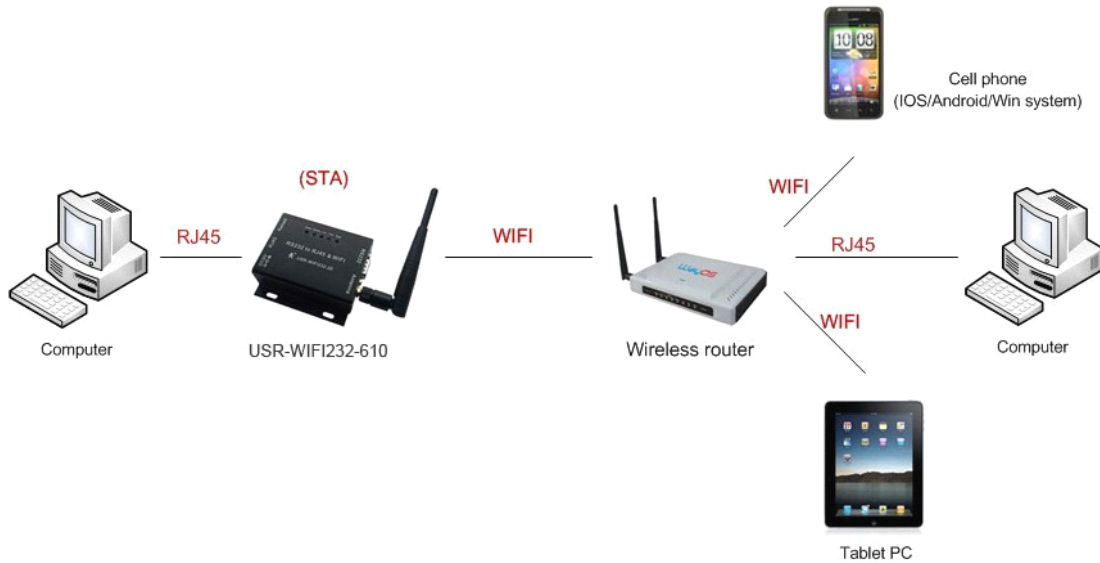

When USR-WIFI232-610 used as STA, network port connected to computer via RJ45, wireless added to wireless router to networking.

4.5. Application of wireless serial port(one AP, one STA)

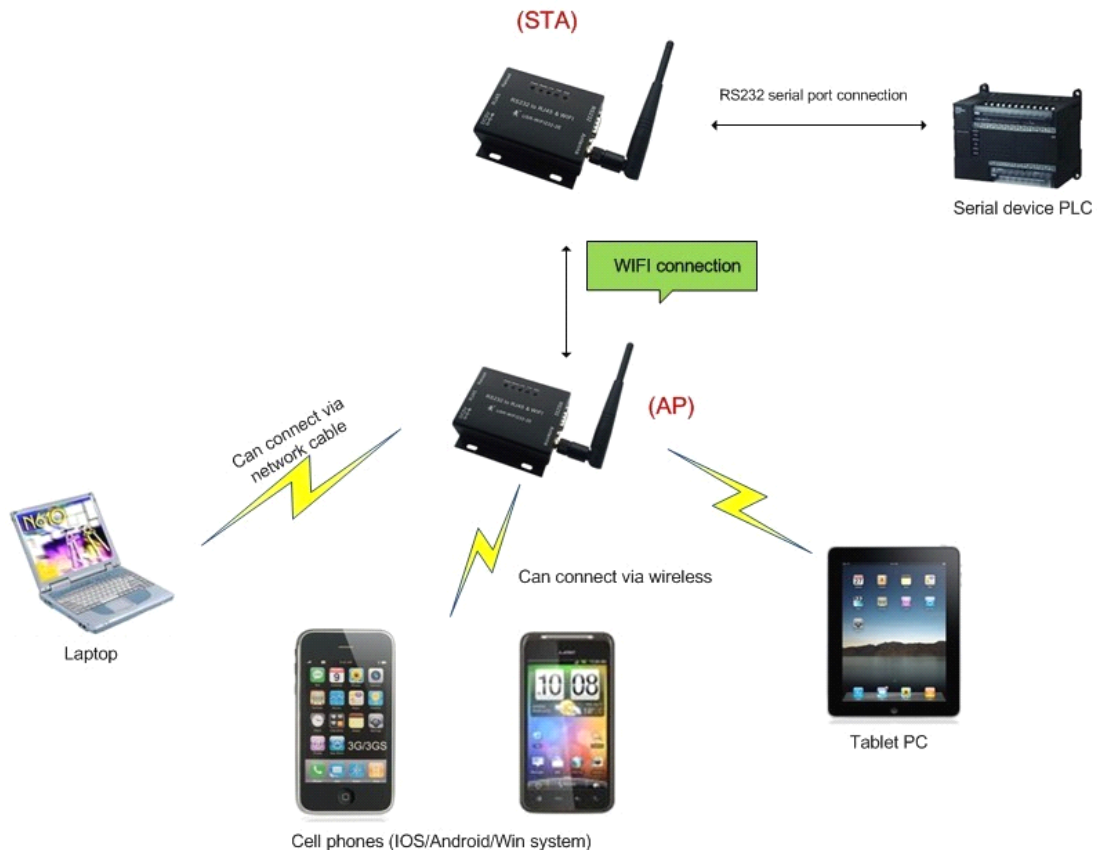

Convert Server can be set as STA or AP. So the device logically supports two wireless interfaces, one as STA, another interface is equivalent to a AP, other STAs can connect to wireless network via the Convert Server AP interface.

5. Function Description

5.1. User configuration process

After Convert Server electric starter, based on user pre-set parameters, automatically connect to wireless networks and servers, and enter the working mode is set to open in accordance with the default serial port parameters.

The parameters which need to configure include:

- Wireless Network Parameters
 - ✧ Wireless Network Name (SSID)
 - ✧ Security Mode
 - ✧ Encryption Key

- TCP/UDP Linking Parameters
 - ✧ Protocol Type
 - ✧ Link Type (Server or Client)
 - ✧ Target Port ID Number
 - ✧ Target Port IP Address

 - Serial Port Parameters
 - ✧ Baud Rate
 - ✧ Data Bit
 - ✧ Parity (Check) Bit
 - ✧ Stop Bit
 - ✧ Hardware Flow Control

 - Work Mode Selection
 - ✧ Transparent transmission/Serial command mode/GPIO mode/HTTPD Client mode
- The following sections will introduce specific to each part in detail.

5.2. Working mode

5.2.1. Transparent Transmission Mode

Convert Server support serial interface transparent transmission mode. The benefit of this mode is achieves a plug and play serial data port, and reduces user complexity furthest. In this mode, user should only configure the necessary parameters. After power on, Convert Server can automatically connect to the default wireless network and server.

As in this mode, the Convert Server's serial port always work in the transparent transmission mode, so users only need to think of it as a virtual serial cable, and send and receive data as using a simple serial. In other words, the serial cable of users' original serial devices is directly replaced with the Convert Server; user devices can be easy for wireless data transmission without any changes.

The transparent transmission mode can fully compatible with user's original software platform and reduce the software development effort for integrate wireless data transmission.

Notes: Users also open the serial port hardware flow control (CTS/RTS) function, so that we can make the bit error rate to a minimum. If the user doesn't need hardware flow control function of the serial port, only need to the corresponding pin foot (CTS/RTS) hung up.

5.2.2. Serial command mode

In this mode, the user can send the serial data to a different server address, this pattern can be use UDP or TCP client sends data to the server.

Customer MCU send packets according to the following format, parsing Convert Server is finished, only the n bytes of data sent to the destination address. When data is returned, not analytical data from serial port output directly.

Table 6 Protocol table of Serial command mode

frame header	length	function byte	Backup data area	Destination port	Target address	Data	Sum check
2	2 (n+m+5)	1	2	2	m	n	1

frame header:

0x55 0xAA (Constant)

Length:

Starting from the function byte, to Sum check (does not contain the sum check) all bytes. **High byte at the front**

Function byte:

Bit0: (UDP:0 ;TCP:1)

Bit1: (Short connection:0;Long connection:1)

Bit2: (IP:0;Domain name:1)

Bit7: (cut protocol:0;full protocol:1) **Note: currently only supports cut protocol**

Notes:

- ✧ Bit1: If it is a short connection, it sends data, and then will be disconnected; if it is long connection, it sends data, connection will remain, until the re changing the target address.
- ✧ Bit2: Indicates that the target address is IP or domain name. If it is IP, the target address is 4 bytes; if the domain name, the target address length for the entire domain name string length (the last byte address is '\0', that is the end of the string).
- ✧ Bit7: Under the cut protocol, reply frame contains only data; Under the full protocol, reply frame has "failed to send", "waiting for", "UDP radio response equipment IP" frame data.

Backup data area:

- ✧ First byte: If it is a short connection, this position is TCP waits for the timeout time (1-255), if the send command is completed, did not receive a response, then wait a few seconds and the corresponding, if 5, said to wait for the 5S to disconnect; if the sending command, immediately receive the returned data, then immediately disconnected; if it is long connection, this position is 0x00.
- ✧ Second byte: Reserve

Destination port:

Little endian, low byte in the former, such as port 23, here are 0x17 0x00

Target address:

If it is IP, is 4 bytes, for example, 192.168.0.7 said 0x07 0x00 0xA8 0xC0; if it is a domain name, then the address of indefinite length, ending with the '\0'.

Data:

Variable length,the maximum not exceeding 1000bytes.

Sum check:

From the function word to check byte (does not contain a check byte), add Sum check.

The following is an example of a specific application:

```
send data:0x55 0xaa 0x00 0x0a 0x00 0x00 0x00 0x21 0x00 0x85 0x00 0xA8 0xC0 0x01 0x0f
Length:0x00 0x0a
Function byte:0x00 (UDP;Short connection;IP;cut protocol)
Destination port:0x21 0x00(33)
Target address:0x85 0x00 0xA8 0xC0 (192.168.0.133)
Data:0x01(data length :1)
Sum check:0x0f (0x00+0x00+0x00+0x21+0x00+0x85+0x00+0xA8+0xC0+0x01=0x0f)
```

5.2.3. HTTPD Client mode

This mode is used to send data to the HTTP server.

After setting the HTTP header format by webpage or AT command, the data sent each time by UART will add the HTTP header automatically.Convenient for the user directly submit data or read data from the HTTP server.

Below is the specific application, for example:

The first set HTTP parameters using AT instructions.

AT+HTTPURL=192.168.1.1,80	The serveraddress and portsettings
AT+HTTPTP=POST	Set the HTTP type, GET, PUT or
POST	
AT+HTTPPH=/set	Set the path,the mostis50 bytes
AT+HTTPCN=keep-alive	Set the Connection,maximum length
of 20bytes	
AT+HTTPUA=lwip13.2	Set the User-Agent,maximum length
of 20bytes	

If the sending data is 1234.In the 80 port of 192.168.1.1 will receive the following data

```
POST /set HTTP /1.1
Connection:keep-alive
User-Agent:lwip1.3.2
Content-Length:4
Host:192.168.1.1:80
```

1234

If the HTTP type is GET, the 80 port 192.168.1.1 receive data

```
POST /set1234 HTTP /1.1
Connection:keep-alive
User-Agent:lwip1.3.2
Content-Length:0
```

Host:192.168.1.1:80

Data received from server will be directly sent to the serial port,without any treatment.

5.3. WI-FI parameter setting

5.3.1. Auto- Frequency Function

When Convert Server works as STA, Convert Server will adjust its wireless channel to keep the same channel with associated AP and connect in.

When Convert Server works as AP and Convert Server enable Auto-frequency function, then when Convert Server boot up, it will select the best wireless channel based on surrounding environment.

5.3.2. Security

Convert Server supports multiple wireless encryption mechanisms, and enables to protect the security of user's data transmission, the mechanisms include:

- ◆ WEP
- ◆ WPA-PSK/TKIP
- ◆ WPA-PSK/AES
- ◆ WPA2-PSK/TKIP
- ◆ WPA2-PSK/AES

5.3.3. Search Function for STA

When using web configuration STA Interface Setting Page, user can push "Search" button to find surrounding AP, and find a AP to associated.

STA Interface Parameters	
AP's SSID	USR-WIFI232-AP_3378 <input type="button" value="Search..."/>
MAC Address (Optional)	<input type="text"/>
Security Mode	OPEN ▾
Encryption Type	NONE ▾

Figure 6 Search page

5.3.4. Address Binding

Convert Server supports the feature of binding the BSSID address of target network.

According to the provisions of 802.11 protocol, different wireless networks can have a same network name (i.e. SSID / ESSID), but must correspond to a unique BSSID address (i.e. MAC address). Illegal intruders can create a wireless network with the same SSID / ESSID, it will make STAs in the network to join to the illegal AP, thereby and then network leakage happen.

Users can prevent STA from joining to illegal network by binding the BSSID address, to improve wireless network security.

5.4. UART Frame Scheme

5.4.1. UART Free-Frame

Convert Server support UART free-frame function. If user select open this function, Convert Server will check the intervals between any two bytes when receiving UART data. If this interval time exceeds defined value (50ms default), Convert Server will think it as the end of one frame and transfer this free-frame to WiFi port, or Convert Server will receive UART data until 4K bytes, then transfer 4KB frame to WiFi port.

Convert Server's default interval time is 50ms. User can also set this interval to fast (10ms) through AT command. But user have to consider if user MCU can send UART data with 10ms interval ,or the UART data may be divide as fragment.

Through AT command: AT+FUARTTE=fast/normal, user can set the interval time: fast (10ms) and normal (50ms). This command is factory default setting command and AT+RELD can't change its value.

5.4.2. UART Auto-Frame

Convert Server support UART auto-frame function. If user select open this function and setting auto-frame trigger length and auto-frame trigger time parameters, then Convert Server will auto framing the data which received from UART port and transmitting to the network as pre-defined data structure.

- **Auto-frame trigger length:** The fixed data length that Convert Server used to transmitting to the network.
- **Auto-frame trigger time:** After the trigger time, if UART port received data can't reach auto-frame trigger length, then Convert Server will transmitting available data to the network and bypass the auto-frame trigger length condition.

Detailed UART auto-frame function can refer to AT+ instruction set “UARTF/UARTFT/UARTFL” introduction.

5.5. Network Setting

Convert Server has two TCP/UDP Socket: Socket A and Socket B. Serial data written to the Convert Server, will be sent to the Socket A and B simultaneously; TCP/UDP data that Convert Server receives through either Socket A or B, will be sent to the serial port.

Dual Socket through different settings, you can achieve a variety of network interconnect. When the Convert Server shipped only open Socket A, Socket B default is not to connect, if the user needs to use, please set by AT commands.

5.5.1. Socket A

Socket A has three work mode: TCP Server, TCP Client, UDP. The setting method, please refer to the AT+NETP command instruction.

When Socket A configured as TCP Server, it supports Multi-TCP link connection, and maximum 32 TCP clients permitted to connect to Socket A.

Multi-TCP link connection will work as following structure:

Upstream: All data from different TCP connection or client will be transmitted to the serial port as a sequence.

Downstream: All data from serial port (user) will be duplicate and broadcast to every TCP connection or client.

Detailed multi-TCP link data transmission structure as following figure:

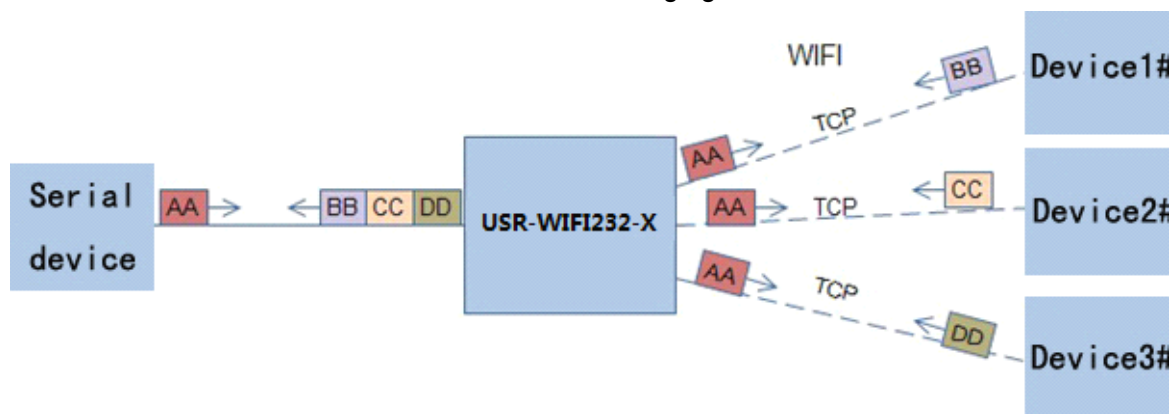

Figure 7 Multi-TCP Link Data Transmission Structure

5.5.2. Socket B

Socket B has one work mode: TCP Client, please refer to the AT + SOCKB command instruction.

With variety work mode, socket B can provide users with flexible data transfer methods. For example, Socket B can connect to a remote server in order to achieve remote control.

5.6. New function

This chapter is based on the function of V4.02.10.USR13 and above, if not this version you can skip this section.

5.6.1. TCP password authentication

This feature is available only on the Convert Server as a TCP server, when the TCP client connection Convert Server, the Convert Server will authenticate each connected tcp.

Each TCP client first data is the "password+0x0d+0x0a" (the password is Webpage authentication password). The default password is "admin", so the first piece of data should be "0x61 0x64 0x6D 0x69 0x6E 0x0D 0x0A" (Hex). If the password is correct, the Convert Server returns "OK", on the other hand, return to the "NO" and disconnect.

The TCP connection of this function can be Webpage in "TCP connection password authentication" is opened or disable. Please refer to the specific "5.1.2" section.

5.6.2. Upload ID

This function only applies to the Convert Server as a TCP client, in front of the data when Convert Server connected to the server with two bytes of ID (ID the range is 0 ~ 65535, the high byte before, and the low byte behind) plus two bytes ID radix-minus-one complement. Convert Server is the default ID is 1111, for example, is sent to the server when the first four bytes "0x57 0x04 0xfb 0xa8".

There are two ways to upload their own id: one is to upload their own id for connection to the server for the first time; The other is a plus id in front of each data.

ID number related parameter is set in the "serial port and other Settings" section of the web, build joint function of ID for the first time, and each data with the function of ID are opened by default.

ID can also use the at command to set the related parameters, specific refer to 5.2.1.4.32-5.2.1.4.34 section.

5.6.3. Self-adaption Baudrate

This feature, please cooperate with our company's virtual serial port software use.

Use a serial port connected Convert Server, and use the at command "at + AABR = on" open this function and restart. In the USR - VOXM software "synchronous baud rate (RFC2217 similar)" is selected, the following figure.

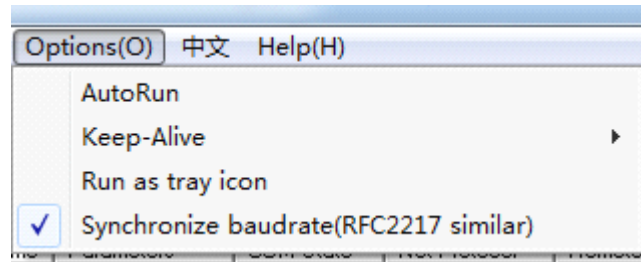
**Figure 8 RFC 2217**

In this way, the Convert Server of baud rate will be as the USR-VCOM to change at any time, and don't have to restart the Convert Server. If restart the Convert Server, baud rate and will come back to before.

5.6.4. Keepalive

V4.02.10. USR13 and above version of the firmware added keepalive when the TCP connection mechanism, so when the Convert Server of network anomalies, timely diagnose abnormal to the network and disconnect, when the network has resumed after, and just in time to connect to the server.

5.6.5. Multiple STA parameters

This function based on V4.02.10.USR18 and above version of the firmware, in the sta mode, if can network signal is too low, it will automatically switch to the other AP network (switching network automatically restart). This feature provides a signal threshold, when the current network signals is lower than the critical value, the Convert Server of automatic switching network and restart. If the signal value is set to 100, the Convert Server will not switch network. Even if the current network signal is not the current network will always search, not heavy to other networks.

The function of the specific Settings page refer to section 4.5.4.

5.6.6. Websocket

This Convert Server can realize the function of the websocket server, allowing serial real-time interaction with the web Convert Server, replace the previous HTTP GET, POST, corresponding faster. This Convert Server provides the corresponding websocket test page for user testing, specific page is as follows: (web

Page: 10.10.100.254/websocketen.html)

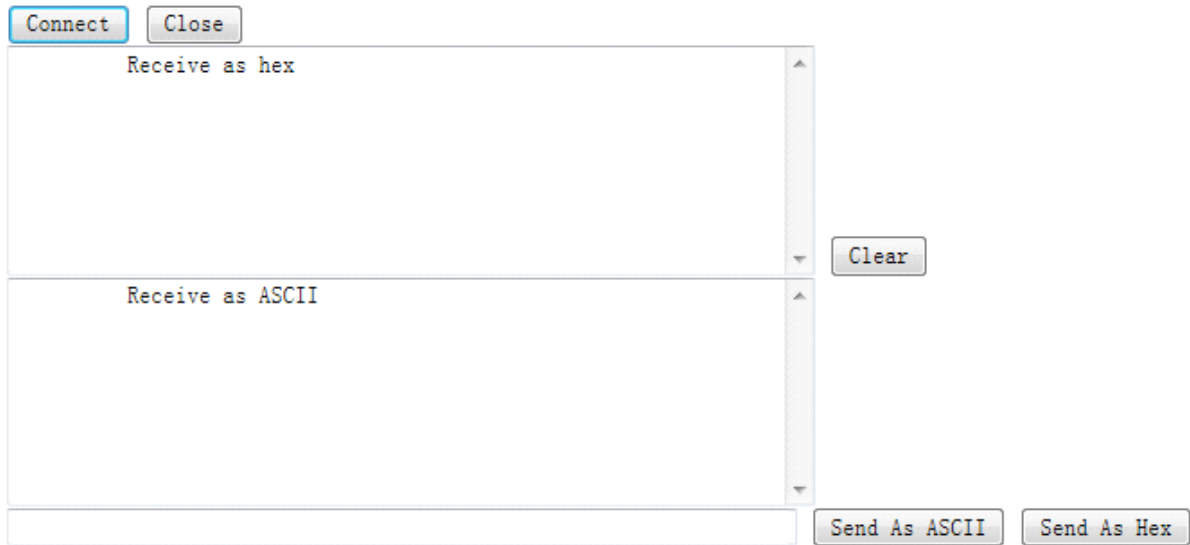

Figure 9 Websocket Page

Click on the "connect" page and then implements a connection, so a serial port with page can send or receive data from each other. This Convert Server websocket server support 8 client connection at the same time. This function for web applications, and for web users with higher response speed, if you want to customize the corresponding web page, can connect your company.

5.7. Palmodic Signal

Base on selected factory default setting, "Ready" signal can have two output statuses:

- ✧ Status One: The Convert Server will output "0" after normal boot up. This signal used to judge if Convert Server finish boot up and ready for application.
- ✧ Status Two: The Convert Server will output "Palmodic Signal" after normal boot up. The palmodic signal is 0.5Hz square wave with dutyfactor 1:1. User can query this signal to judge if Convert Server is active "live" or need to re-boot. When Convert Server switches to command mode, it will output "0", which used to distinguish work mode and command mode.

Notes:

This function is user selected factory setting and RELD instruction will not effective for this function. If user not requires this function, the default factory setting is Status One. Contact with USR Technology for more detailed support.

5.8. Parameters Configuration

Convert Server Convert Server supports two methods to configuration parameters: **Web Accessing** and **AT+instruction set**.

Web accessing means users can configure parameters through built-in webpage. When Convert Server Convert Server connected to wireless network, parameters configuration is done on a PC connected to the

same wireless network. AT+instruction set configuration means user configure parameters through serial interface command. Refer to “AT+instruction set” chapter for more detail.

Notes:

USR can customized the parameters setting as customer request and ship Convert Server with these parameters as factory default configuration. It will reduce user’s Convert Server configuration time for mass production. Also, if user need different parameters setting for every Convert Server, USR can provide the auto-configuration tool to speed up the Convert Server configuration duration. Please contact USR technical interface to acquire this tool if required.

5.9. Firmware Upgrade

Convert Server supports firmware upgrade online.

6. setup process

6.1. Configuration via Web Accessing

When first use Convert Servers, user may need some configuration. User can connect to Convert Server’s wireless interface with following default setting information and configure the Convert Server through laptop.

Web Access Default Setting

Parameters	Default Setting
SSID	USR-WIFI232-XXX_XXXX
IP Address	10.10.100.254
Subnet Mask	255.255.255.0
User Name	admin
Password	admin

6.1.1. Open Web Management Interface

Step 1: Connect laptop to SSID “USR-WIFI232-XXX_XXXX” of Convert Server via wireless LAN card;

Step 2: After wireless connection OK. Open browser and access “<http://10.10.100.254>”;

Step 3: Then input user name and password in the page as following and click “OK” button.



Figure 10 Open Web Management page

The Convert Server web management page support English and Chinese language. User can select language environment at the top right corner and click “Apply” button.

The main menu include nine pages: “Quick Configure”, “Mode Selection”, “AP Interface Setting”, “STA Interface Setting”, “Application Setting”, “Ethernet Setting”, “HTTPD Client mode”, “WEB IO” and “Device Management”.

6.1.2. Quick Configure

This page provides users with a method of rapid configuration Convert Server. Users according to the steps to configure the parameters and restart the Convert Server page, you can let the Convert Server is normal work, reduced the configuration steps and time. Of course the options on this page is less, if some detailed configuration, still need to the corresponding configuration page.

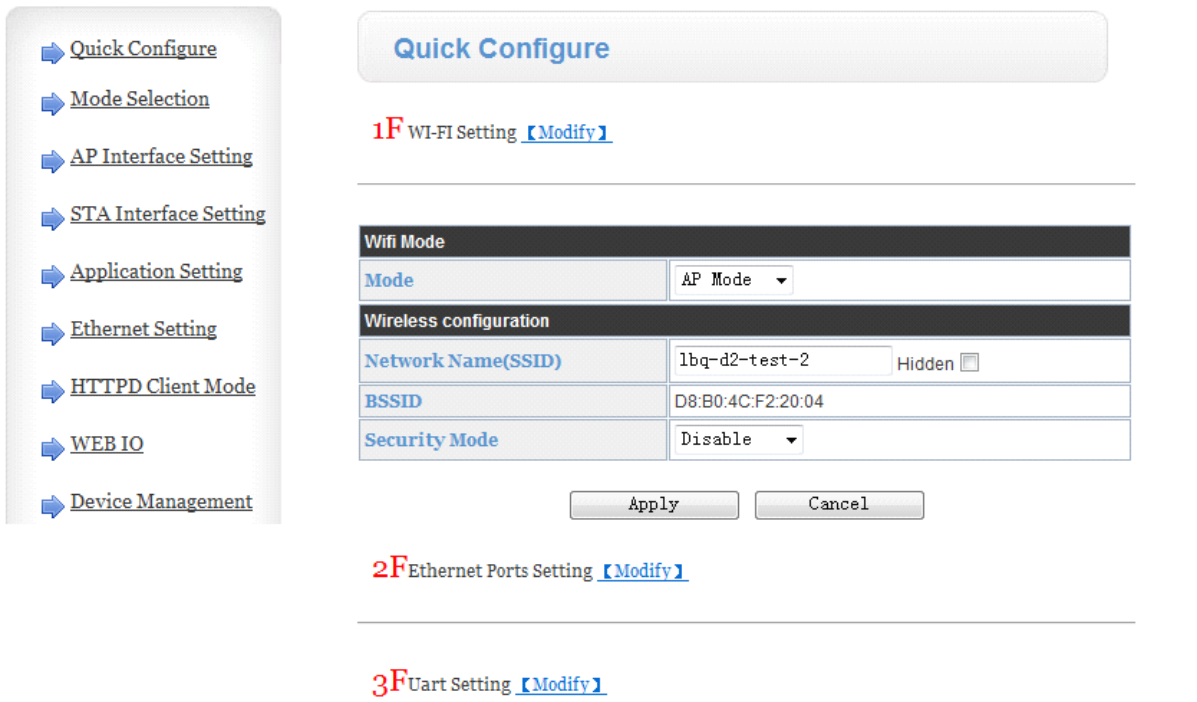

Figure 11 Quick Configure Page

This page has four configuration options and a restart, the corresponding instructions below:

- ◆ WI-FI Setting: set the working mode of wifi, AP mode or the STA.
- ◆ Ethernet Ports Setting: open/close the Ethernet ports, and set up the corresponding work mode.
- ◆ UART Setting: set serial port parameters, including baud rate, parity bit, 485 functions and so on.
- ◆ Network Setting: set network parameters, Only TCPA related parameters.
- ◆ Device Management: when after completion of the above parameters are configured, click reset Convert Server.

6.1.3. Mode Selection Page

This page use to setting the wireless networking mode (AP and STA mode).

"Data transmission mode" selection Convert Server working mode are "Transparent Mode", "Serial Command mode", "GPIO mode"and""HTTPD-Client Mode".

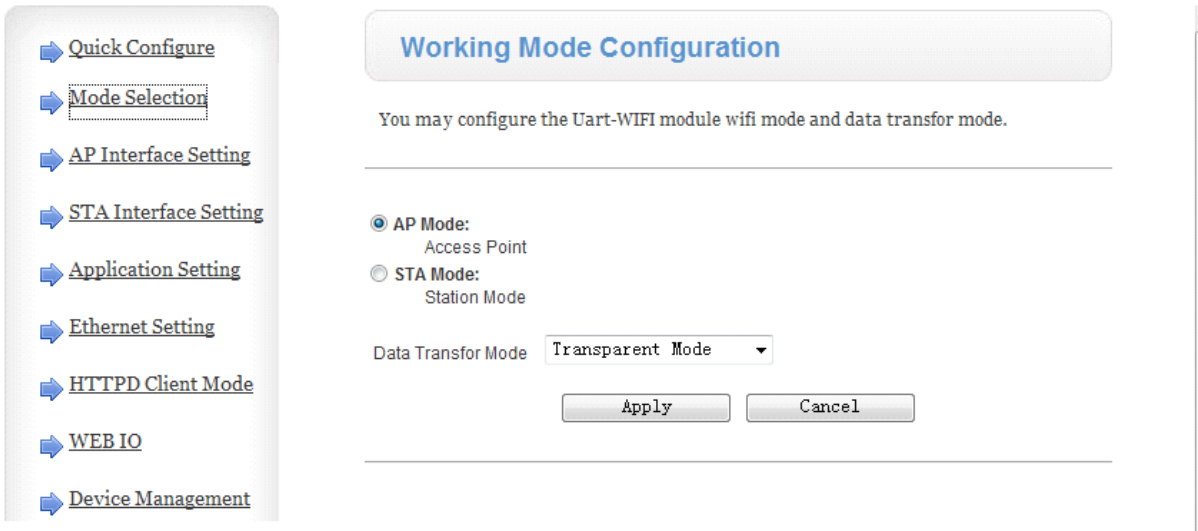

Figure 12 Mode Selection Page

6.1.4. AP Interface Setting Page

This page use to setting the parameters when Convert Server works as AP.

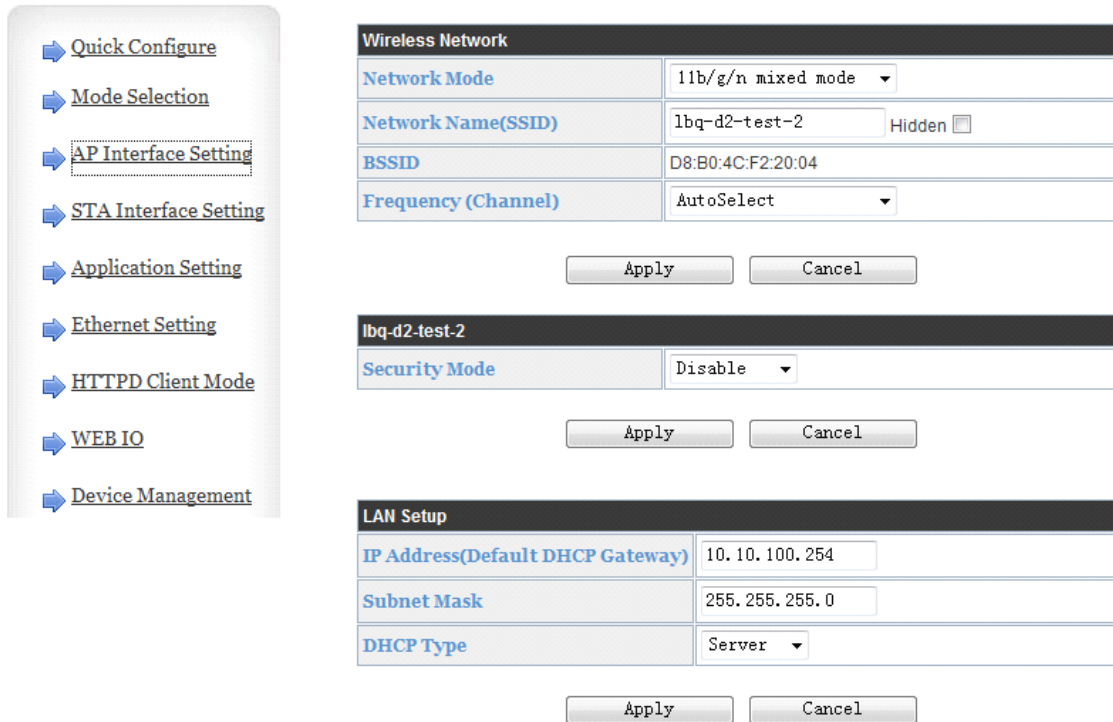

Figure 13 AP Interface Setting Page

6.1.5. STA Interface Setting Page

This page use to setting the parameters when Convert Server works as STA.

Such as SSID of AP which Convert Server need to connected, and also select the networking type: DHCP or static IP address.

- ➔ [Quick Configure](#)
- ➔ [Mode Selection](#)
- ➔ [AP Interface Setting](#)
- ➔ [STA Interface Setting](#)
- ➔ [Application Setting](#)
- ➔ [Ethernet Setting](#)
- ➔ [HTTPD Client Mode](#)
- ➔ [WEB IO](#)
- ➔ [Device Management](#)

STA Interface Parameters	
AP1's SSID	USR-WIFI232-AP4 <input type="button" value="Search..."/>
MAC Address1 (Optional)	<input type="text"/>
Security Mode1	OPEN ▾
Encryption Type1	NONE ▾
AP2's SSID	USR-WIFI232-AP2 <input type="button" value="Search..."/>
MAC Address2 (Optional)	<input type="text"/>
Security Mode2	OPEN ▾
Encryption Type2	NONE ▾
AP3's SSID	USR-WIFI232-AP3 <input type="button" value="Search..."/>
MAC Address3 (Optional)	<input type="text"/>
Security Mode3	OPEN ▾
Encryption Type3	NONE ▾
Signal threshold	2 <input type="text"/> % Note: The signal is less than this value, Switching network

Figure 14 STA Interface Setting Page

6.1.6. Application Setting Page

This page use to setting the parameters of serial port communication, such as UART setting,UART AutoFrame Setting,Ethernet function,Device ID setting and high layer network protocol setting which used support serial communication.

- ➔ [Quick Configure](#)
- ➔ [Mode Selection](#)
- ➔ [AP Interface Setting](#)
- ➔ [STA Interface Setting](#)
- ➔ [Application Setting](#)
- ➔ [Ethernet Setting](#)
- ➔ [HTTPD Client Mode](#)
- ➔ [WEB IO](#)
- ➔ [Device Management](#)

- ➔ [Quick Configure](#)
- ➔ [Mode Selection](#)
- ➔ [AP Interface Setting](#)
- ➔ [STA Interface Setting](#)
- ➔ [Application Setting](#)
- ➔ [Ethernet Setting](#)
- ➔ [HTTPD Client Mode](#)
- ➔ [WEB IO](#)
- ➔ [Device Management](#)

Uart Setting	
Baudrate	57600 ▾
Data Bits	8 ▾
Parity	None ▾
Stop	1 ▾
CTSRTS	Disable ▾
485 mode	Disable ▾
Baudrate adaptive (RFC2117)	Enable ▾

UART AutoFrame Setting	
UART AutoFrame	Disable ▾

Device ID setting	
Device ID (0-65535)	1111
Send an ID when module connection is established	Enable ▾

Network A Setting	
Mode	Server ▾
Protocol	TCP ▾
Port	8899
Server Address	10.10.100.100
MAX TCP Num. (1~32)	32
TCP Time out (MAX 600 s)	0
TCP connection password authentication	Disable ▾

Socket B Setting	
Open the SocketB function	on ▾
Port	8899
Server Address	www.zhangkongbao.com
TCPB Time out (MAX 600 s)	0

Figure 15 Application Setting Page

Notes:

Generally, Network protocols support three modes: **TCP Server**, **TCP Client**, **UDP Server**, **UDP Client**. When the Convert Server is configured to UDP server side, the Convert Server will memory the UDP client end of the last communication, and communication with this UDP client. While the UDP client mode will only

with the target IP address and communication. When set to the TCP Server, do not need to enter the IP address. For other Settings, need to fill in the need to connect each other IP address. Fill in port with protocol port number, at the ends of the communication port number must be the same.

The Socket B only as a TCP client terminal to communicate with the server.

TCP connection password authentication: when the Convert Server in the TCP server mode, password authentication on the TCP client connect to.

Note: this verification is only in a Convert Server as a TCP server. After the opening, the TCP client connected Convert Server, the first data which sent to the Convert Server is password and carriage returns. The password is the password to login page default is "admin". Such as the default when sending the first data should be "0x61 0x64 0x6D 0x69 0x6E 0x0D 0x0A" (hex).

6.1.7. Ethernet Setting

This page is used to set two Ethernet front-end ports of the Convert Server, two Ethernet front-end ports can be open or closed. And so the second can be set to the WAN port to use, this Convert Server can be used as a secondary router, making it easy for users to network. Specific Settings page is as follows:

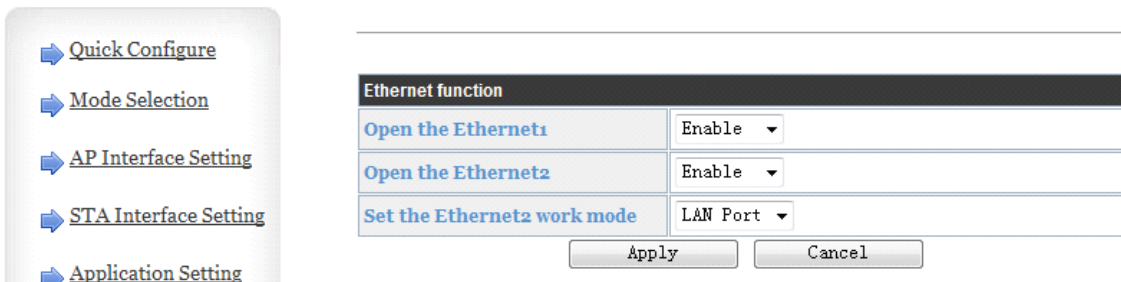

Figure 16 Ethernet Setting Page

6.1.8. HTTPD Client Mode

This page sets the HTTP header in the HTTPD Client mode. Include: the address of the server, the server port, request type, protocol header path, Connection, user-agent.

HTTPD Client mode support POST, PUT, GET three HTTP request types. Is a POST or PUT request way, serial data can be added to the back of the HTTP header; When the request is a GET, data can be added to the back of the path in the HTTP header. The specific way of sending data can consult section 4.2.4.

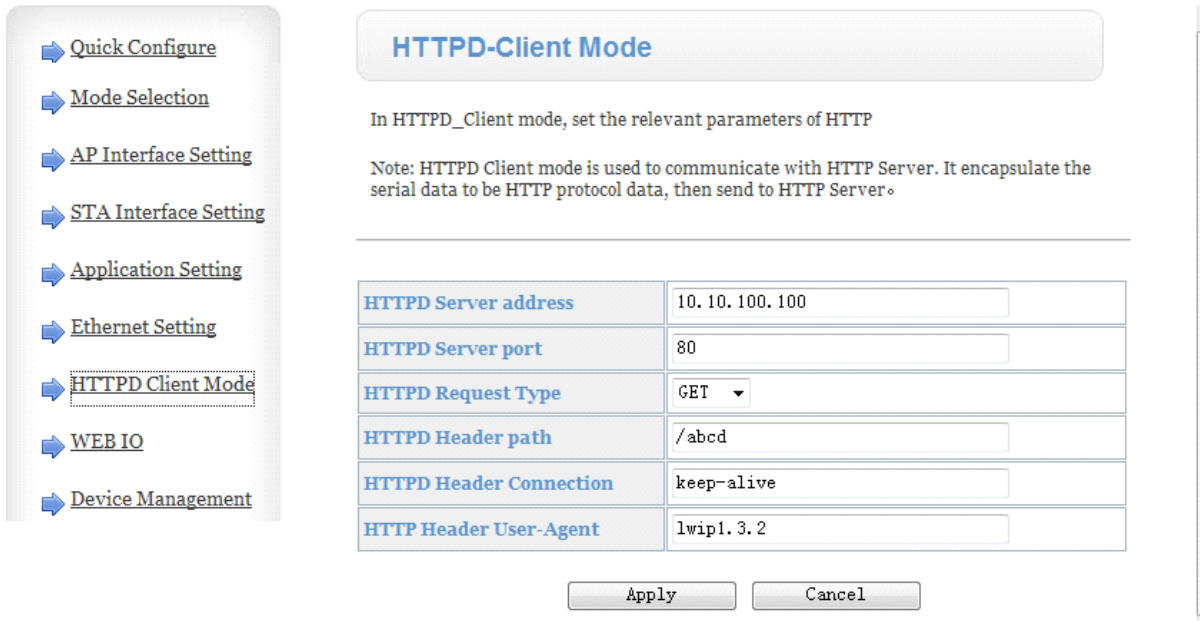

Figure 17 HTTPD Client Mode Page

6.1.9. Device Management Page

This page use to manage Convert Server general setting, such as administrator setting, restart Convert Server button, restore factory default setting button, and update firmware through webpage.

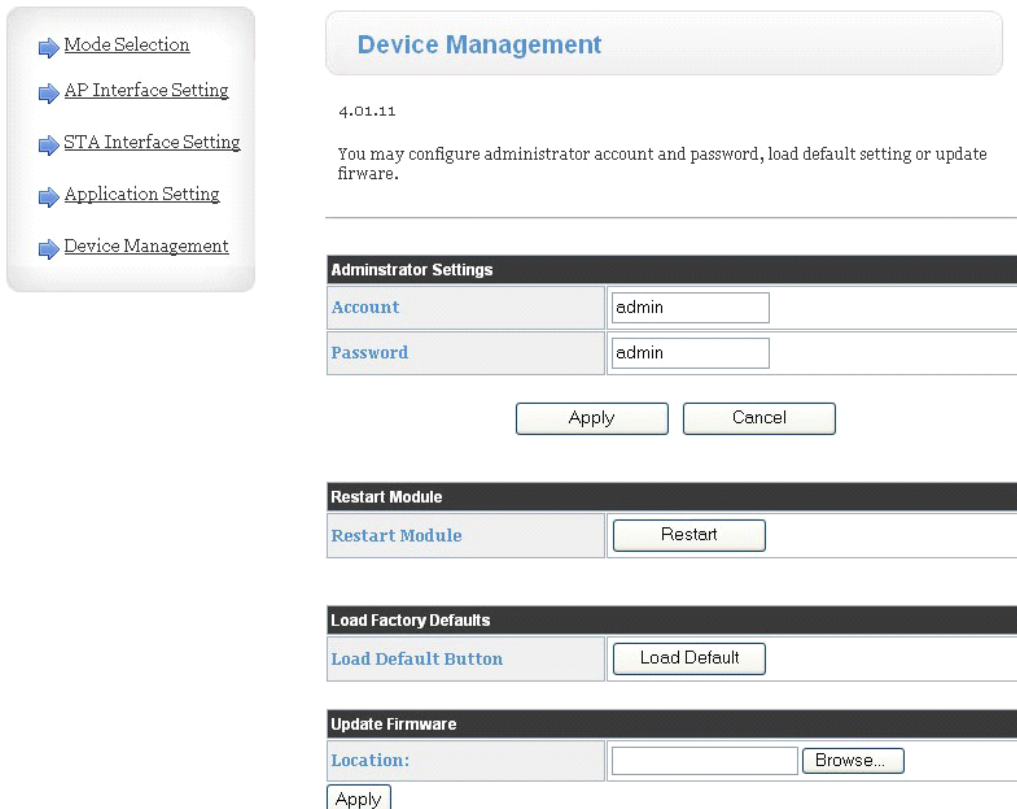

Figure 18 Device Management Page**Notes:**

Restart module button: When you setting the parameters of different web pages, you will click “Apply” button to confirm the setting, but the setting take effect only after user click the “Restart” button here, the Convert Server will re-boot up and refresh the memory information with new changes.

Appendix A: Questions and Answers

Q1: How to configure transparent serial port application (TCP protocol) with two Convert Servers?

➤ Network structure as below figure:

■ Convert Server 1# Setting:

- ✧ Works as AP mode; --See "Mode Selection Page"
- ✧ LAN IP address: 10.10.100.254; --See "AP Interface Setting Page"
- ✧ Network Protocol:TCP/Server, Port ID: 8899; -- See "Application Setting Page"
(Convert Server default setting);

■ Convert Server 2# Setting:

- ✧ Works as STA mode; --See "Mode Selection Page"
- ✧ WAN connection type: DHCP or Static IP (For this example:10.10.100.100) --See "STA Interface Setting Page"

- ✧ Network Protocol:TCP/Client, Port ID: 8899; Application IP address: Convert Server 1#'s LAN IP address (10.10.100.254); -- See "Application Setting Page"
- ✧ **Notes:** When Convert Server 2# works as STA mode, Convert Server's WiFi interface works as WAN port. Convert Server's WAN IP address and LAN IP address shall be setting different segment. So, Convert Server 2#'s LAN IP address must change to other segment; (For this sample, we change to 10.10.99.254); --See "AP Interface Setting Page"

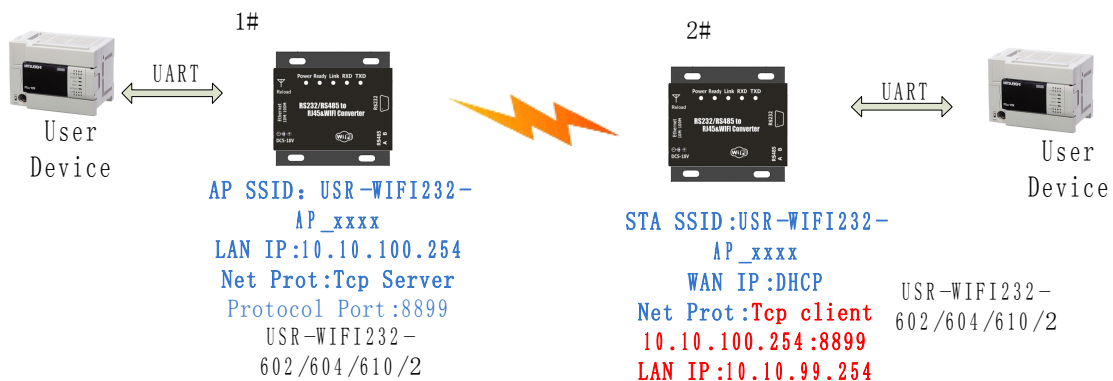

Figure 19 Configure Transparent Serial Port Connection (TCP)

Q2: Where to Set WIFI Convert Server LAN IP and WAN IP through Web Page?

- USR-WIFI232-D2 Wireless LAN IP address setting see “AP Interface Setting Page” as below Figure,

LAN Setup	
IP Address	10.10.100.254
Subnet Mask	255.255.255.0
MAC Address	88:8B:5D:70:04:87
DHCP Type	Server
Default DHCP Gateway	10.10.100.254

Figure 20 Convert Server LAN IP Setting

- USR-WIFI232-D2 Wireless WAN IP address setting see “STA Interface Setting Page” as below Figure, User can set WAN connection type to DHCP and STATIC IP.

WAN Connection Type:

Static Mode	
IP Address	10.10.99.254
Subnet Mask	255.255.0.0
Default Gateway	10.10.99.254

Figure 21 Convert Server WAN IP Setting

Q3: How to configure transparent serial port application (UDP protocol) with two Convert Servers?

- Network structure as below figure:

- Convert Server 1# Setting:

- ✧ Works as AP mode; --See “Mode Selection Page”
 - ✧ LAN IP address: 10.10.100.254; --See “AP Interface Setting Page”
 - ✧ Network Protocol:UDP, Port ID: 8899; Application IP address:10.10.100.100;

-- See “Application Setting Page”

- Convert Server 2# Setting:

- ✧ Works as STA mode; --See “Mode Selection Page”
 - ✧ WAN connection type: Static IP (10.10.100.100)

--See “STA

Interface Setting Page

- ✧ Network Protocol:UDP, Port ID: 8899; Application IP address: Convert Server 1#'s LAN IP address (10.10.100.254); *-- See "Application Setting Page"*
- ✧ LAN IP address: 10.10.99.254 (Different net segment with WAN port) *--See "AP Interface Setting Page"*

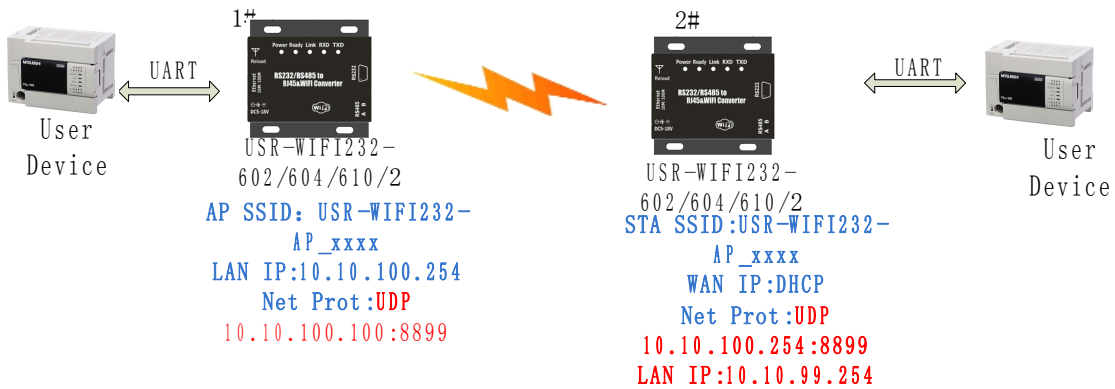

Figure 22 Configure Transparent Serial Port Connection (UDP)

Q4: Where to set Convert Server network protocol (TCP/UDP)?

- USR-WIFI232-D2 network protocol setting see "Application Setting Page" as below Figure,
 - Protocol: TCP Server
 - ✧ Only Port ID required: 8899 (Default)

Net Setting	
Mode	Server
Protocol	TCP
Port	8899
IP Address	10.10.10.100
TCP Time out (MAX 600 s)	300

Figure 23 Convert Server Network Protocols: TCP/Server

- Protocol: TCP Client
 - ✧ Application IP address required: it's target TCP server 's IP address;
 - ✧ Port ID required: 8899 (Default)

Net Setting	
Mode	Client
Protocol	TCP
Port	8899
IP Address	10.10.10.100
TCP Time out (MAX 600 s)	300

Figure 24 Convert Server Network Protocol: TCP/Client

- Protocol: UDP
 - ◇ No Server/Client selection required;
 - ◇ Application IP address required: it's target device 's IP address;
 - ◇ Port ID required: 8899 (Default)

Net Setting	
Mode	Client
Protocol	UDP
Port	8899
IP Address	10.10.10.100

Figure 25 Convert Server Network Protocol: UDP

Q5: How to configure transparent serial port application: Two Convert Servers all configured as STA and connection through AP?

- Network structure as below figure:
 - Convert Server 1# Setting: (We use USR-WIFI232-D2 as AP for this example)
 - ◇ Works as AP mode and all default setting;
 - Convert Server 2# Setting:
 - ◇ Works as STA mode; --See "Mode Selection Page"
 - ◇ WAN connection type: Static IP: 10.10.100.100; --See "STA Interface Setting Page"
 - ◇ Network Protocol:TCP/Server, Port ID: 8899; -- See "Application Setting Page"
 - ◇ LAN IP address: 10.10.99.254 (Different net segment with WAN port);
--See "AP Interface Setting Page"
 - Convert Server 3# Setting:
 - ◇ Works as STA mode; --See "Mode Selection Page"
 - ◇ WAN connection type: Static IP: 10.10.100.101; --See "STA Interface Setting Page"
 - ◇ Network Protocol:TCP/Client, Port ID: 8899; Application IP address: Convert Server 2#'s WAN IP address (10.10.100.100); -- See "Application Setting Page"

✧ LAN IP address: 10.10.98.254 (Different net segment with WAN port);

--See "AP Interface Setting Page"

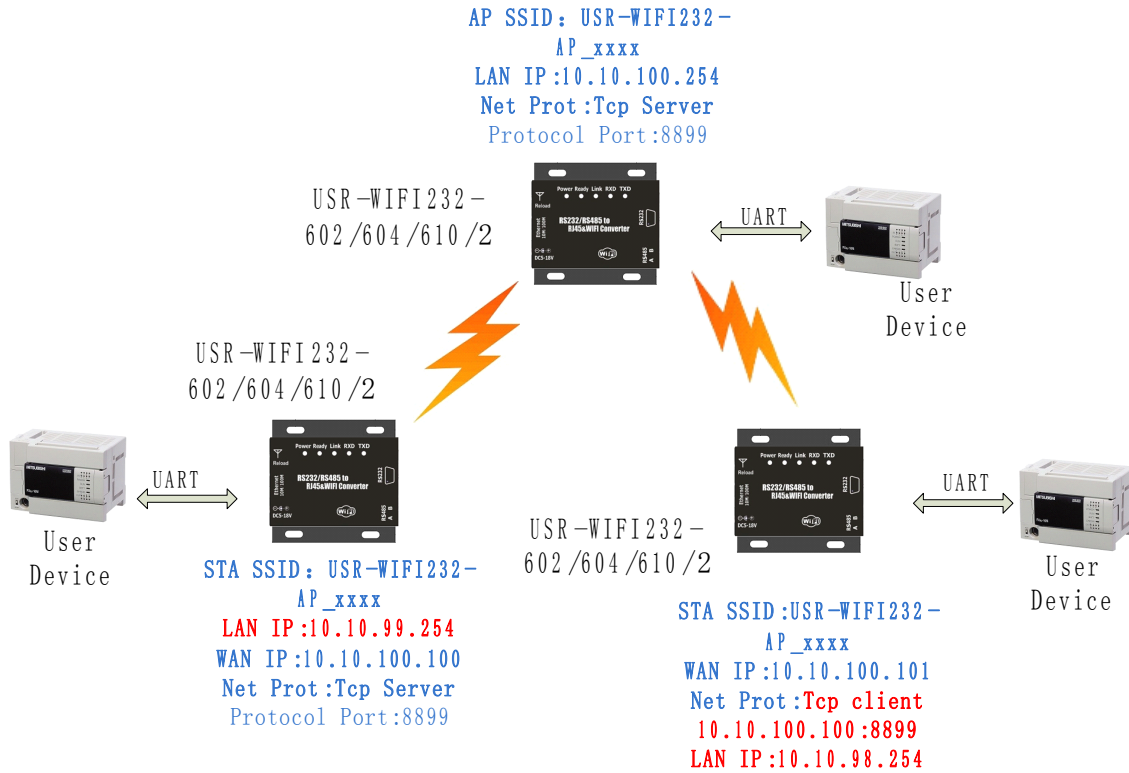

Figure 26 Two Convert Servers Connection Through AP

Q6: How to avoid IP address conflict when apply Convert Server?

- The following address allocation method can avoid the IP address conflict for dynamic and static IP address mixed application.
 - Convert Server dynamic IP address range from 100 to 200 for last IP address segment.
 - ✧ Such as default IP: 10.10.100.254. When Convert Server works as AP, the IP address Convert Server can allocate to STA is from 10.10.100.100 to 10.10.100.200;
 - So, if user needs to set static IP for dedicated STA internal network, the available IP address range can start from 10.10.100.1 to 10.10.100.99.

Q7: PC works as server, all Convert Servers works as data acquisition card and connect with PC, how to configure this application?

- Network structure as below figure: Three Convert Server setup 3 TCP links with PC server. Convert Server 1# works as AP and all devices connect to Convert Server 1# through WiFi interface;

- **PC Setting:**
 - ✧ IP address: 10.10.100.100;
 - ✧ Network Protocol:TCP/Server, Port ID: 8899;
- **Convert Server 1# Setting:**
 - ✧ Works as AP mode;
 - ✧ LAN IP address: 10.10.100.254;
 - ✧ Network Protocol:TCP/Client, Port ID: 8899; Application IP address:10.10.100.100;
- **Convert Server 2# Setting:**
 - ✧ Works as STA mode;
 - ✧ WAN connection type: Static IP: 10.10.100.101;
 - ✧ Network Protocol:TCP/Client, Port ID: 8899; Application IP address:10.10.100.100;
 - ✧ LAN IP address: 10.10.99.254 (Different net segment with WAN port);
- **Convert Server 3# Setting:**
 - ✧ Works as STA mode;
 - ✧ WAN connection type: Static IP: 10.10.100.102;
 - ✧ Network Protocol:TCP/Client, Port ID: 8899; Application IP address:10.10.100.100;
 - ✧ LAN IP address: 10.10.98.254 (Different net segment with WAN port);

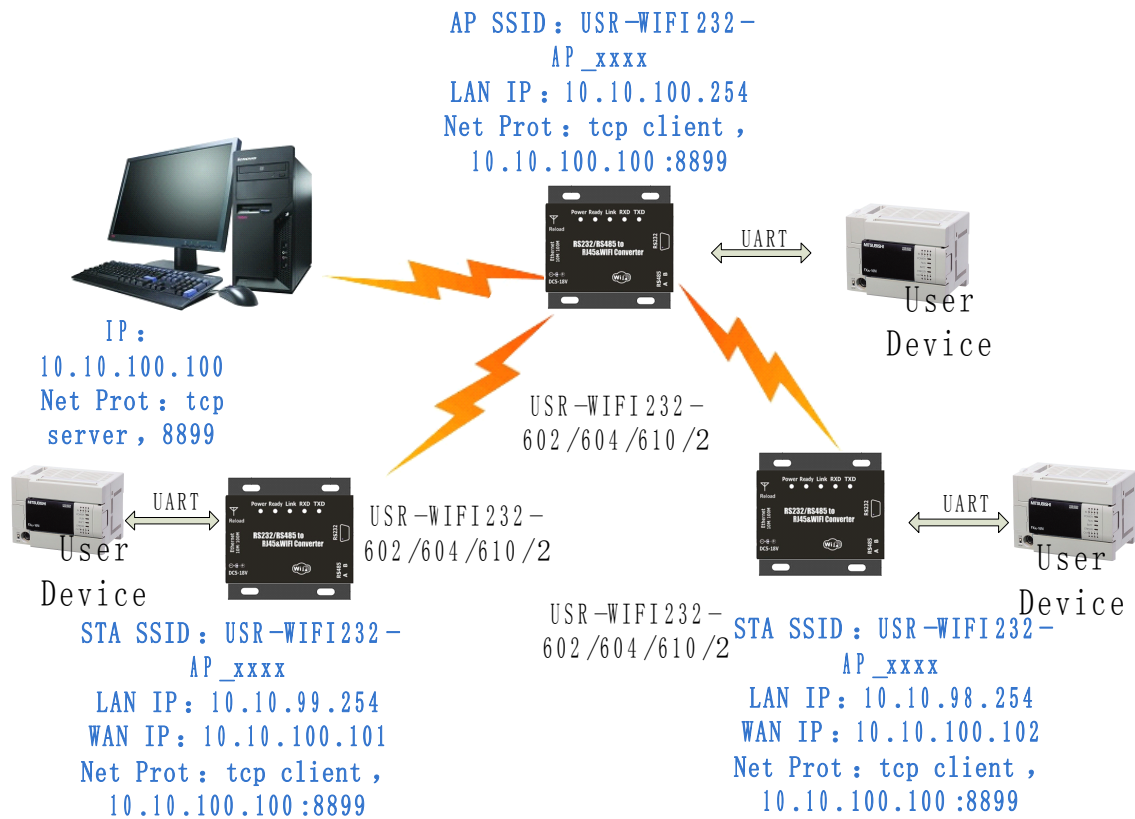

Figure 27 Wireless Data Acquisition Card Setting

Q8: Convert Server support UDP multicast?

At present, all the Convert Server does not support UDP multicast function, IP multicast address range is "224.0.0.0~ 239.255.255.255", When setting Convert Server, please don't set this IP section, if set, may cause the Convert Server can't normal start.

Q9: Convert Server operates in STA mode, the PC how to get the IP Convert Server?

All Convert Server supports UDP search, they will return to their respective IP, MAC, MID, detailed search process is as follows:

1. PC via UDP broadcast (broadcast address: xx.xx.xx.255, Port: 48899) sent a password, the default password is: "HF-A11ASSISTHREAD", the password can be used AT commands (AT + FASWD) set up, it's Up to 100 bytes.

2. After the Convert Server receives a password, if the password is correct, to the address (Unicast, Port: 48899) sends local IP address and MAC address and name of the Convert Server. (IP, MAC, MID as 10.10.100.254,888 B5D0000E2, guxin).

So you can get to the IP address of the Convert Server.

Appendix B: Contact

Company: Jinan USR IOT Technology Limited
Address: 1-728, Huizhan Guoji Cheng, Gaoxin Qu, Jinan, Shandong, China
Tel: 86-531-55507297, 86-531-88826739
Web: <http://www.usriot.com>
Support : <http://h.usriot.com>
Email: sales@usr.cn

Appendix C: Disclaimer

This document provides information about RS232/RS485 TO RJ45&WIFI CONVERT SERVER, this document does not grant any license to intellectual property rights. Except the responsibility declared in the product sale clause, USR does not assume any other responsibilities. In addition, USR does not make any warranties for the sale and use of this product, including the suitability of the product for a particular purpose, merchantability or fitness for any patent, copyright or other intellectual property infringement, etc. USR may make changes to specifications and product descriptions without notice.

Appendix D: Update History

2014-01-09 V1.0 created
2014-07-24 V2.0 Increase the HTTPD Client model/serial command mode, modify the GPIO mode. Increase the TCP password authentication, Keepalive, Websocket, upload ID, adaptive baud rate, etc.
2014-11-12 V2.0.1 Modify wireless SSID
2015-05-28 V2.0.2 Modify the minimum temperature - 40
2015-06-16 V2.0.3 Increase customer support center link, remove WAPI encryption.